

# LESSON ONE

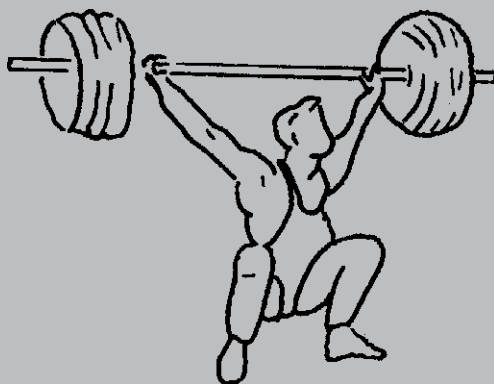

# LESSON ONE

## PHYSICAL FITNESS

### New Words:

**fit:** in shape; healthy and strong.

(I keep fit by going swimming every morning.)

**healthy:** well; not ill; how well your body is.

(You can keep healthy by eating well and exercising regularly.)

**depressed:** very sad; without hope.

(He felt very depressed about the future.)

**burn up:** use energy by doing exercises.

(Which burns up more calories, swimming or cycling ?)

**nervous:** worried or afraid.

(I felt very nervous before the examination.)

**tension:** being worried because you are waiting for something.

(Tension can give you headaches.)

**improve:** make or become better.

(Your English has improved a lot this year.)

### (I)

Many people eat too much and exercise too little. They feel tired and heavy. They look older than they really are and often feel depressed. Many other people are thin and nervous. They eat the wrong kinds of food and they burn up a lot of energy because of nervous tension. They, too, often feel tired and depressed. What is the solution for such people ? How can they improve their bodies?



Thin

How can they become healthy ? Read on and find out!

## UNDERSTANDING

**PART A:** Which of the following sentences are true and which are false ? Write “T” or “F” before the sentence !

- \_\_\_\_\_ 1. All the thin and nervous people look older than they really are.
- \_\_\_\_\_ 2. Eat too much and exercise little!
- \_\_\_\_\_ 3. Nervous and depressed people are not usually healthy.

**PART B:** Write complete answers to the following questions !

1. What does “they” in line 6 refer to ?
2. What makes some people burn up a lot of energy ?
3. Who often feels tired and depressed ?

**PART C:** Choose the best answer !

1. According to the passage, if you eat too much, you may feel \_\_\_\_\_  
a. thin and nervous                      b. tired and heavy  
c. improve your body                      d. find the solution
2. Nervous people \_\_\_\_\_ their energy through tension.  
a. improve                      b. borrow  
c. burn-up                      d. gain
3. If you eat the right kinds of food, you \_\_\_\_\_  
a. will stay healthy                      b. feel depressed and tired  
c. should exercise to stay strong and healthy  
d. will never need to exercise to stay strong and healthy
4. The word “heavy” in line 2 is \_\_\_\_\_  
a. an unhealthy sign                      b. essential to good health  
c. a healthy sign                      d. a solution for such people

## **PART D: Imperatives**

Read these sentences .Put a check mark (✓) in front of the correct imperatives.

1. Amir is hungry.

Tell Amir what to do!

Eat some food!

Drink some water!

2. Your friend eats the wrong kind of food.

Tell your friend what to do !

Improve your body!

Eat the right kind of food!

3. Ali feels tired and depressed.

Tell him what to do.

Do some exercises!

Eat too much!

4. My uncle is depressed and nervous .

Tell me what to do for him!

Leave him alone.

Read and find out!

## **New Words:**

**tighten:** cause something to become tight or firm.

**co-ordinate:** cause(different parts,limbs,etc.) to function together efficiently.

**posture:** way in which a person holds himself as he stands, walks or sits.

**abdomen:**part of the body below the chest and diaphragm,containing stomach,bowels and digestive organs.

**vital:** very important; something that you must do or have.

(It is vital to warm yourself up before doing heavy exercises.)

**soccer:** football.

(In the United States, football is known as soccer.)

**circulate:** move in a closed path.

(Blood circulates in the body as water does in the heating system of a house.)

**relaxing :** helping you to rest or become less anxious.

(After a hard day at work, you need a relaxing evening.)

**breathe :** take in and let out air through your nose and mouth.

(The coach told me to breathe in and then breathe out again slowly.)

## II

Exercise is vital to good health . A walk around the block or to the corner for a newspaper is not much exercise. Swimming, tennis, basketball and soccer are good examples of sports which use all the muscles in the body. The muscles are tightened; the heart beats faster and circulates the blood through the body; breathing and co-ordination improve. Furthermore, these sports are enjoyable and relaxing.

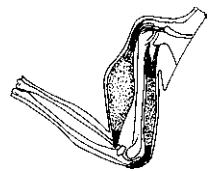

a muscle

## UNDERSTANDING

**PART A:** Which of the following sentences are false and which are true? Write “T” or “F” before the sentence !

- \_\_\_\_\_ 1. A good sport is one which involves almost all the muscles in the body.
- \_\_\_\_\_ 2. A walk round the block is enough exercise.
- \_\_\_\_\_ 3. Sports are only for enjoyment and relaxation.

**PART B:** Write complete answers to the following questions !

1. Which sports are relaxing and enjoyable?
2. What is vital to good health ?

3. What happens to muscles during sport activities ?

**PART C:** Choose the best answer !

1. The heart \_\_\_\_\_ the blood through the body .  
a. circulates                      b. improves  
c. invites                          d. contains
2. A good physical exercise \_\_\_\_\_ the co-ordination among the body systems.  
a. tightens                      b. relaxes  
c. blocks                        d. improves
3. In \_\_\_\_\_ sport activities \_\_\_\_\_ circulates through the body faster and better .  
a. all / breathing              b. some / blood  
c. a few / oxygen              d. any / exercise

**PART D :** Imperatives

Read these sentences. Put a check mark (✓) in front of the correct statements.

1. I think my muscles are weak .  
Tell me what to do  
 Buy a newspaper!  
 Exercise .
2. Mr Akbari feels he is depressed and tired,  
Tell him what to do!  
 Go swimming!  
 Stop exercising!
3. Reza is looking for something enjoyable and relaxing .  
Tell him what to do!  
 Sit in a corner!  
 Play soccer ,tennis or basketball!

### III

For many people , a gymnasium is an excellent place to lose weight, improve posture and tighten muscles. Both men and women can improve their bodies in a gym. Sit-ups, push-ups and other stretching and pulling exercises strengthen the neck, the shoulders, the back, the arms and the abdomen. Men lift weights of from five to two hundred pounds to build up their shoulders, arms and chest. They also work on horizontal and parallel bars and stationary bicycles. Some men squeeze hard rubber balls to strengthen their fingers and wrists.

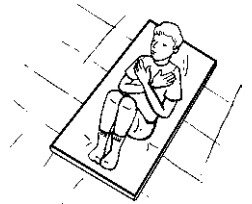

sit ups

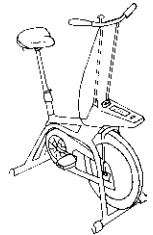

stationary bicycle

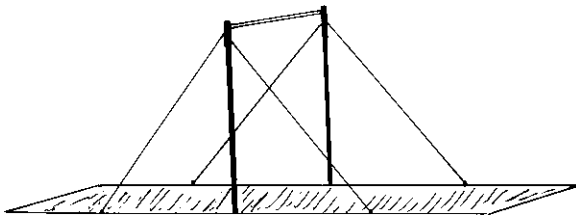

horizontal bar

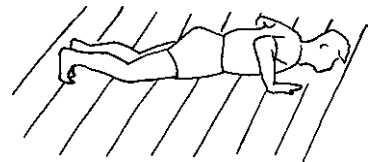

push - ups

## UNDERSTANDING

**PART A:** Write “ T” or “F” before the sentence !

- \_\_\_\_\_ 1. Stretching not pulling exercises strengthen the neck, the shoulders the back and the arms .
- \_\_\_\_\_ 2. A gymnasium is a good place for sports activities .
- \_\_\_\_\_ 3. Sit-ups and push-ups are good examples of stretching exercises.

**PART B:** Write complete answers to the following questions !

1. What is a gymnasium ?
2. What can people do in a gym ?
3. Why do men lift weights ?
4. What can help everyone to improve posture?

**PART C:** Choose the best answer !

1. Fat people try to \_\_\_\_\_ weight .  
a. gain                      b. strengthen      c. lose      d. develop
2. Sit-ups and push-ups \_\_\_\_\_ muscles.  
a. squeeze      b. break down      c. contain      d. strengthen
3. Some men also \_\_\_\_\_ hard rubber balls to make their wrists strong.  
a. study                      b. lift      c. build-up      d. squeeze

**PART D:** Imperatives

Read these sentences .Put a check mark (✓) in front of the correct imperative.

1. My cousin is very fat.  
Tell him what to do!  
 Go to a gymnasium!  
 Go to a restaurant!
2. I would like to do some stretching and pulling exercises .  
Tell me what to do!  
 Try push-ups!  
 Try the hard rubber balls
3. Mr Bahrami wishes to build up his shoulders and arms .  
Tell him what to do .  
 Ride bicycles !  
 Try weight lifting !
4. I think my wrists and fingers are not strong enough .  
Tell me what to do !  
 Squeeze rubber balls !  
 Squeeze balls !



## WORD FORMATION ( I )

<b>STUDY THE EXAMPLES :</b>	true	truth
	develop	development
	examine	examination
	depress	depression

Add the appropriate endings to form suitable nouns !

1. tense \_\_\_\_\_
2. improve \_\_\_\_\_
3. circulate \_\_\_\_\_
4. co-ordinate \_\_\_\_\_
5. strong \_\_\_\_\_

<b>STUDY THE EXAMPLES :</b>	enjoy	enjoyable
	use	useful / useless
	hunger	hungry
	fame	famous
	office	official

Add the appropriate endings to form suitable adjectives !

1. thirst \_\_\_\_\_
2. harm \_\_\_\_\_
3. vary \_\_\_\_\_
4. benefit \_\_\_\_\_
5. nerve \_\_\_\_\_

## WORD FORMATION (II)

**Use the appropriate form of the word in the corresponding sentence!**

- (benefit) 1. Exercise is \_\_\_\_\_ to everyone.
- (harm ) 2. Smoking is \_\_\_\_\_ to the lungs.
- (depression) 3. Everyone feels \_\_\_\_\_ once in a while .
- (variety) 4. There are \_\_\_\_\_ ways to lose weight or gain it.
- (swim ) 5. Why are \_\_\_\_\_ and tennis good exercises ?

## SENTENCE COMPLETION

Use the words in the box to complete the sentences that follow.  
(There are more words than you need.)

nervous	energy
horizontal	relaxation
healthy	muscle
thirsty	health
essential	heart

1. Those lines are not vertical ; they are \_\_\_\_\_
2. The heart is a \_\_\_\_\_
3. I am \_\_\_\_\_. I want a glass of water .
4. The \_\_\_\_\_ helps circulate the blood .
5. Our coach worries about our \_\_\_\_\_ a lot .
6. Athletes usually burn up a lot of \_\_\_\_\_.
7. \_\_\_\_\_ is necessary for everyone.

## TEST YOURSELF

Use the words in the circle to complete the sentences next to or following each picture!

running                      weight lifter                      wrestlers  
exercising                      push ups                      barbell                      tightened

1. This man is \_\_\_\_\_. In picture c, he is doing \_\_\_\_\_.

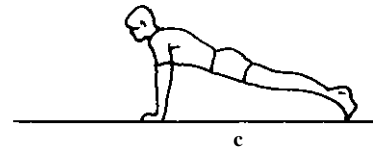
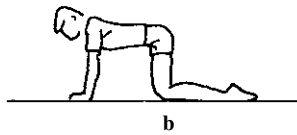
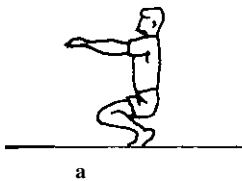

2. The muscles are \_\_\_\_\_ in this type of exercise .

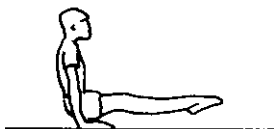

3. This man is a \_\_\_\_\_ . You can see his \_\_\_\_\_ .

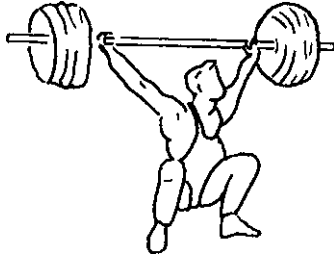

4. These men are \_\_\_\_\_ .

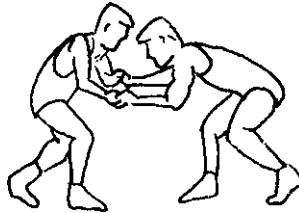

5. These two men are \_\_\_\_\_ .

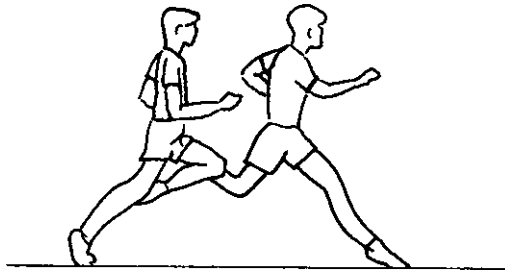

# LESSON TWO

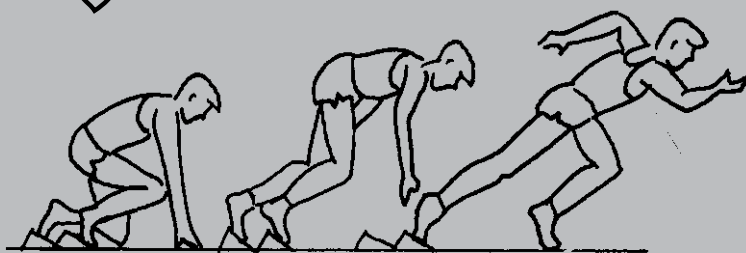

## LESSON TWO

### TRACK AND FIELD (1)

#### **New Words:**

**track and field:** sports that people compete in, such as running and jumping.

**physical education:** lessons in school in which students do physical exercises or take part in physical activities or sports.

**contest:** struggle, competition, fight.

**gymnast:** a person who performs gymnastics especially in competition.

**vaulting:** (also pole vaulting): a field event in which each contestant uses a long pole to vault over a horizontal bar that rests between two upright standards.

**event:** any of individual contests that comprise a sports program.

#### **Dialogue : An introduction to track and field**

Reza : Hi, Ali.

Ali : Hello, Reza. How are you?

Reza : Fine thanks. How about your Physical Education course?

Ali : It's very interesting. The subject for today's class was an introduction Track and Field.

Reza : What is track and field ?

Ali : Track and Field consists of four types of events .

Reza : What are they ?

Ali : Running, jumping, vaulting and weight throwing.

Reza : Is that all ?

Ali : No. We are going to learn more next time.

Reza : OK. Enjoy your course .

Ali : Thanks.

## UNDERSTANDING

**PART A:** Which of the following sentences are true and which are false? Write “ T” or “ F” before the sentence !

- \_\_\_\_\_ 1. Ali and Reza are in the same class .
- \_\_\_\_\_ 2. Track and field is not a type of running.
- \_\_\_\_\_ 3. Reza is going to learn more in his course.

**PART B:** Give oral answers to the following questions!

1. What is vaulting?
2. Is track and field a course in physical education?
3. What are the four types of events in track and field ?

**PART C:** Choose the best answer !

1. Ali is a \_\_\_\_\_ student.
  - a. track and field
  - b. physical education
  - c. weight throwing
  - d. physics
2. The teacher \_\_\_\_\_ the subject today.
  - a. started
  - b. interested
  - c. enjoyed
  - d. finished
3. There are four types of \_\_\_\_\_ in track and field .
  - a. introduction
  - b. course
  - c. subjects
  - d. events

### New Words:

**sprinter:** a person who takes part in a short, fast race.

**sprint:** a short , fast race. ( A 100 meter sprint)

**steeplechase:** a race on a track with some hurdles and a water jump.

**passing zone:** (also exchange zone or take over zone) an area marked in each lane of the track within which the exchange of the baton must take place in a relay race.

**equipment:** the things that are needed for a particular purpose or activity.(We need new equipment for the sports club.)

**fundamental:** serious and very important.

(A fundamental change in the arrangement of the team is needed.)

**distribute:** to place at different points.

(The weight of the table is distributed among the four kegs.)

**disqualify:** prevent somebody from doing something because they have broken a rule. (He was disqualified from the competition for using drugs.)

## The Track Events

The track events are running, sprinting, and hurdling. Some running events such as hurdles and steeplechase require considerable equipment. Some other running events such as sprinting, relays, and distance running, do not.

Sprinting is a basic skill and fundamental to track and field. The runner should be familiar with three main commands: “On your mark”, “Set” and “Go”. For example, to get “Set” means to distribute the weight of the body in the best possible position from which to take off. Concentration should be put on the rear leg and the opposite arm.

There are some basic rules in the track events. In hurdling, for example, the entire body must pass over the hurdle. And in relays we learn that disqualification of one runner disqualifies the entire team. And also the baton must be passed inside the 20 m passing zone.

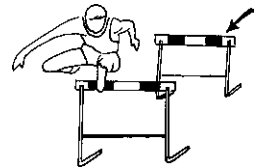

**hurdles**

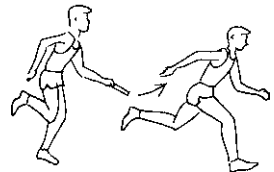

**relays**



**baton**

## UNDERSTANDING

**PART A:** Which of the sentences are true and which are false? Write “T” or “F” before the sentences !

- \_\_\_\_\_ 1. Sprinting is a physical activity.  
\_\_\_\_\_ 2. Jumping is not a track event.

**PART B:** Write complete answers to the following questions !

1. What are the different activities of track events ?
2. What are the three commands in sprinting ?

**PART C:** Choose the best answer !

1. The baton must be passed in \_\_\_\_\_.  
a. hurdling            b. relays  
c. sprinting            d. steeplechase
2. Which of the following is **NOT** a command ?  
a. Go                    b. Set  
c. On your mark    d. 20 m passing zone
3. Sprinting requires \_\_\_\_\_ equipment .  
a. no                    b. considerable  
c. little                d. any
4. Which of the following is a basic rule ?  
a. The hurdler can run around a hurdle.  
b. The baton must be passed inside the 20 m passing zone.  
c. Only the first runner of race must have the baton.  
d. Distribute the weight of the body .
5. A synonym for “require” is \_\_\_\_\_.  
a. need                b. rear  
c. depend            d. distribute
6. The antonym of rear in “the rear leg” is \_\_\_\_\_.  
a. in front of        b. ahead  
c. front                d. back

**PART D :** Complete the sentences about the track events .

1. Sprinting , relays, and distance running \_\_\_\_\_



considerable equipment .

2. In hurdling ,the \_\_\_\_\_ body must pass over the hurdle.

3. Sprinting is \_\_\_\_\_ to track and field .

4. “ On your mark ” is a command, the other two are \_\_\_\_\_ and \_\_\_\_\_.

**PART E:** Choose the correct sentence . Put (✓) before the sentence.

1.

a. The runner should be familiar with 3 main commands.

b. To get “set” means to hurdle .

2.

a. In hurdling, the baton must be passed .

b. In relays, the baton must be passed.

3.

a. Hurdles and steeplechase need equipment.

b. A basic skill in running is “On your mark”.

4.

a. In relays, the entire team passes inside the 20 m zone .

b. There are some basic rules in the track events .

5.

a. The track events are running, baton, and sprinting .

b. The track events are sprinting, hurdling, and running.

## VOCABULARY

Fill in the blank spaces using the words in the box!

quickly	to	track	activities
tedious	as	pleasurable	

Sprinting forms an excellent introduction to \_\_\_\_\_ and field program. Although sprinting is a \_\_\_\_\_ activity, repetition can \_\_\_\_\_ make the activity \_\_\_\_\_ ; it is advisable \_\_\_\_\_ make sprinting part of other \_\_\_\_\_ and events such \_\_\_\_\_ minor games, relays, hurdles, long jumps and triple jumps.

## FREE ACTIVITIES

**PART A : Puzzle .** Fill in the gaps after each statement !

1. The stick carried and passed on by the runners of a relay team:

B \_ \_ \_ n

2. Leaving the starting block or starting line before the gun sounds or making a movement from the set position:

F \_ \_ \_ e s \_ \_ \_ t

3. One of the track events :

H \_ \_ \_ \_ \_ g

4. Preparation of the body through light exercise for more vigorous exercise.:

W \_ \_ m u p

## PART B: TEST YOURSELF

Use the words in the box to complete the sentence(s) under the corresponding picture!

triple	sprinter	running track
starting block	high jumper	
weight throwing	upright	hurdling

1. Identify parts a, b, and c.

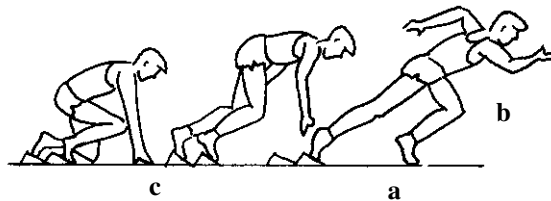

2. This is an example of \_\_\_\_\_.

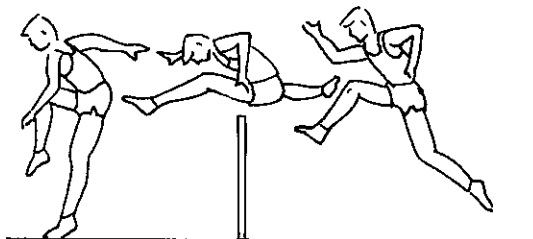

3. The \_\_\_\_\_ is demonstrating shoulder landing .  
The arrow is pointing to the \_\_\_\_\_.

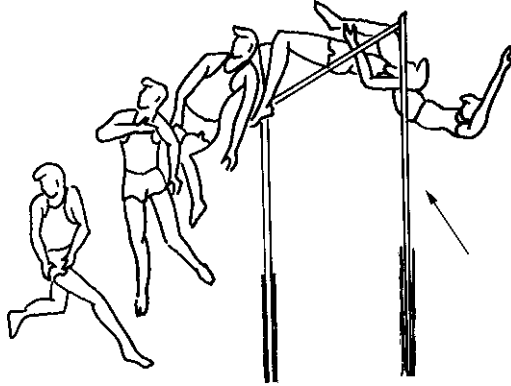

4. This is the \_\_\_\_\_ event .

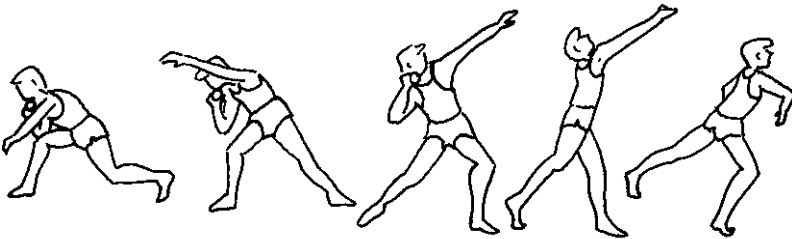

5. This is not the high jump, it is the \_\_\_\_\_ jump.

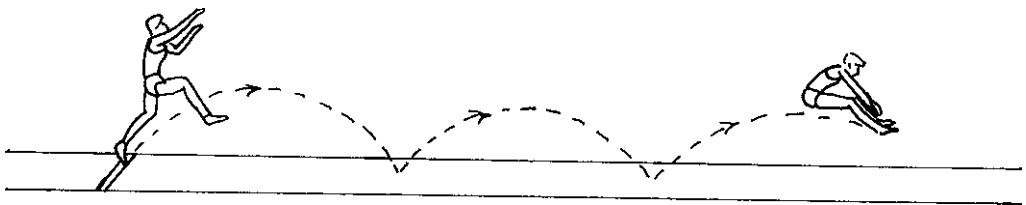

### PART C : TRANSLATION

Translate the following sentences into Persian .

1. The steeplechase is a 3000 meter event for men that includes 28 hurdles jump and 7 water jumps.

2. The sprinter should be relaxed while running to maintain the greatest speed.

# LESSON THREE

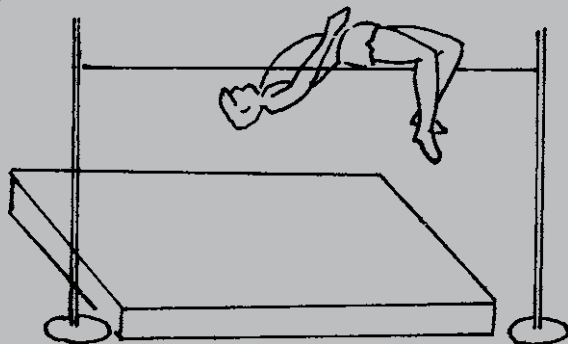

# LESSON THREE

## TRACK AND FIELD (2)

### New Words:

**the triple jump:** a sporting event in which people try to jump as far forward as possible with three jumps. ( Also called hop, step and jump)

**competitor :** a person who takes part in a competition.

**throwing circle:** a circular area in which a competitor must remain during his attempt.

**drag:** move or make something move , partially touching the ground.

(Don't drag your feet on the ground.)

**land:** come on to the ground.

(The hammer landed outside the sector.)

### Dialogue : What do you know about field events ?

Reza : Hi ,Ali .

Ali : Hi, Reza . How are you today ?

Reza : Fine, thanks . What about your track and field class ?

Ali : I find it interesting and useful .

Reza: What are the field events ?

Ali : Throwing and jumping events ?

Reza: What about some interesting rules ?

Ali : Very many . For example , the foot must not drag during the stop phase of triple jump.

Reza: What about the hammer throw ?

Ali : During the throw the competitor must not leave the circle.

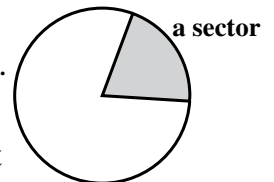
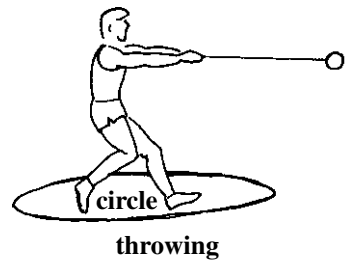

Reza: Yes, and the throw must land within the throwing sector.

Ali : Exactly.

Reza: Ok. Let's go to the long jump and triple jump landing area.

Ali : Ok. Let's go?

### New Words:

**boost:** increase the value or amount of something.

**enthusiasm :** interest or admiration for something.

**lead up activities:** preparatory activities; activities at the beginning of a task.

**run up:** a run made to gain speed for making a jump.

**introductory activities :** lead up activities.

**sprint starts:** a position normally used by competitors at the start of sprint races.

**rate of improvement:** a measurement of the speed at which something becomes better.

(His rate of improvement surprised his coaches.)

### Field Events (A)

The field events are jumping and throwing . The high jump, long jump ,and the triple jump are closely related in that their introductory and lead-up activities are very similar .

Long jump should be one of the first jumping events introduced in the program . It can be taught in combination with triple jump . Instructors can teach these two jumping events immediately after sprinting, sprint starts ,and relays .Many instructors will teach the long jump after the triple jump, for

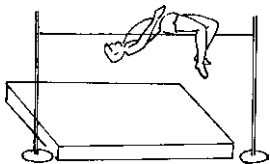

high jump

several reasons. Rates of improvement in triple jump are much higher than for long jump, and this boosts enthusiasm . Also, most youngsters consider the triple jump a lot more fun than the long jump . Finally, the third jump in triple jump is an elementary long jump ,and methods of teaching the run-ups are similar for both events.

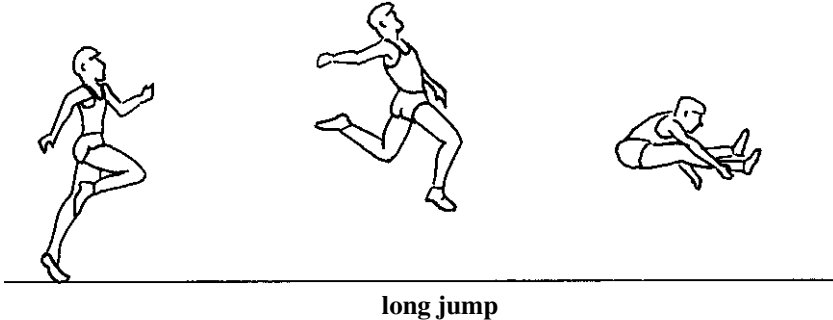

## UNDERSTANDING

**PART A:** Which of the following sentences are true and which are false ? Write “T” or “ F ” before the sentences.

- \_\_\_\_\_ 1. Jumping is a field event ,but throwing isn’t.  
 \_\_\_\_\_ 2. The writer advises the instructor to teach long jump and triple jump after some running events.  
 \_\_\_\_\_ 3. The third jump in triple jump is an elementary jump.

**PART B:** Choose the best answer!

1. “ The introductory and lead-up activities are similar.”

The word “similar” is the same as \_\_\_\_\_.

- |           |              |
|-----------|--------------|
| a. likely | b. different |
| c. alike  | d. same      |
2. “ It can be taught in combination with triple jump.The phrase “in combination with”means\_\_\_\_\_.
- |                   |                     |
|-------------------|---------------------|
| a. separated from | b. together with    |
| c. similar to     | d. independent from |

3. “Instructors can teach these two jumping events immediately”.  
A synonym for “immediately” is \_\_\_\_\_.
- a. right away      b. right now  
c. suddenly      d. hardly
4. “Rates of improvement in triple jumps are higher.” The word  
“improve” means \_\_\_\_\_.
- a. make worse      b. make better  
c. change      d. prove
5. “... and this boosts enthusiasm”. The antonym of “boosts” is \_\_\_\_\_.
- a. forces      b. decreases  
c. increases      d. reduces

**PART C:** Write complete answers to the following questions !

1. Mention two field events and two track events.
2. What boots enthusiasm ?
3. What does “it” in line 6 refer to ?

**New Words:**

**tremendous:** very great.

**shot put:** a field event in which a shot is thrown for distance.

**coordination:** the act of making things work together.

(A basketball player needs the coordination of eyes and hands.)

**spectacular:** impressive; wonderful to see.

(Our team scored a spectacular goal.)

**resemble:** look like; be similar to another person or thing.

(The child resembled her mother.)

**exceed:** be greater than a particular number or amount.

(Prices will not exceed 10 dollars.)



## Field Events (B)

The modern pole vaulter must be a sprinter, weight lifter and, gymnast. The combination of speed, strength and coordination makes this a spectacular event .

Since the introduction of the fiber-glass pole, tremendously performances have been recorded .

Of all throwing events, the javelin throw most closely resembles the normal throwing action. And because the basic throwing action is less complex than other throwing events, javelin throwing is one of the first throwing events introduced.

Among other throwing events one can mention shot put, discus, as well as hammer throw. The hammer consists of a round weight attached to a triangular handle by a wire. It weights 16 pounds (7.25kg) and its total length may not exceed 48 inches (1.2m). It is thrown from a circle 7 feet (2.13m) in diameter.

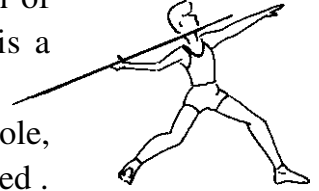

javelin  
throw



triangular  
handle

## UNDERSTANDING

**PART A:** Which of the sentences are false and which are true ? Write “ T” or “ F” before the sentence!

- \_\_\_\_\_ 1. A pole vaulter must have all the other skills.
- \_\_\_\_\_ 2. A lot of records changed a little after the vaulters started using fiberglass poles .
- \_\_\_\_\_ 3. Javelin throwing is not a very complex action.
- \_\_\_\_\_ 4. An example of normal throwing is javelin itself.

**PART B:** Write complete answers to the following questions !

1. What are the characteristics of a modern vaulter ?
2. Mention one jumping and one throwing event !
3. What happened after the introduction of fiberglass pole ?

**PART C:** Choose the best answer !

1. A weight lifter \_\_\_\_\_.  
a. lifts weights                      b. weighs lifts  
c. leaves weights                    d. leaves a lift
2. A spectacular event is one that is \_\_\_\_\_ to see.  
a. good                                  b. OK  
c. interesting                          d. hard
3. "Tremendous" is a synonym for \_\_\_\_\_.  
a. great                                  b. small  
c. little                                  d. unimportant
4. "The javelin throw most closely resembles ..." The word "resemble" means "is \_\_\_\_\_".  
a. same as                                b. such as  
c. the same                                d. similar to

## FURTHER ACTIVITIES

Test yourself

Use the appropriate word to fill the gap under each picture !

bar    glove    vaulter    height scale    handle  
upright                      box    bar    field    high jumping  
grip                      landing area                      vaulting    hammer head

1. An example of field event is \_\_\_\_\_.

The arrow shows the \_\_\_\_\_.

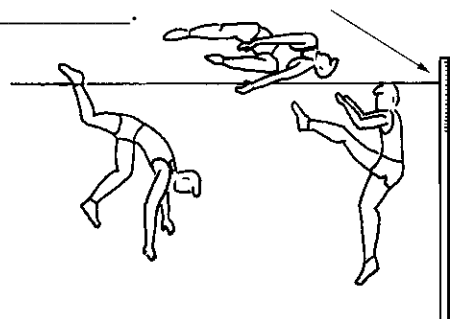

2. The man in the picture is a pole \_\_\_\_\_.  
 A is the \_\_\_\_\_ pole ,and B is the\_\_\_\_\_.

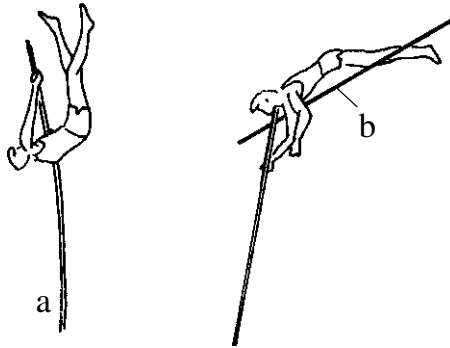

3. Identify the different parts of this high jump equipment.

a. \_\_\_\_\_ b. \_\_\_\_\_  
 c. \_\_\_\_\_ d. \_\_\_\_\_

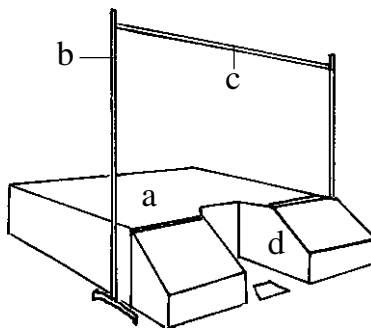

4. Identify parts 1 and 2 !

1. \_\_\_\_\_ 2. \_\_\_\_\_

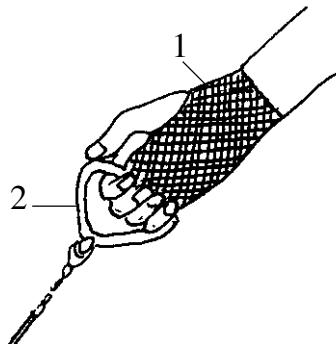

5. These men are demonstrating two \_\_\_\_\_ events.

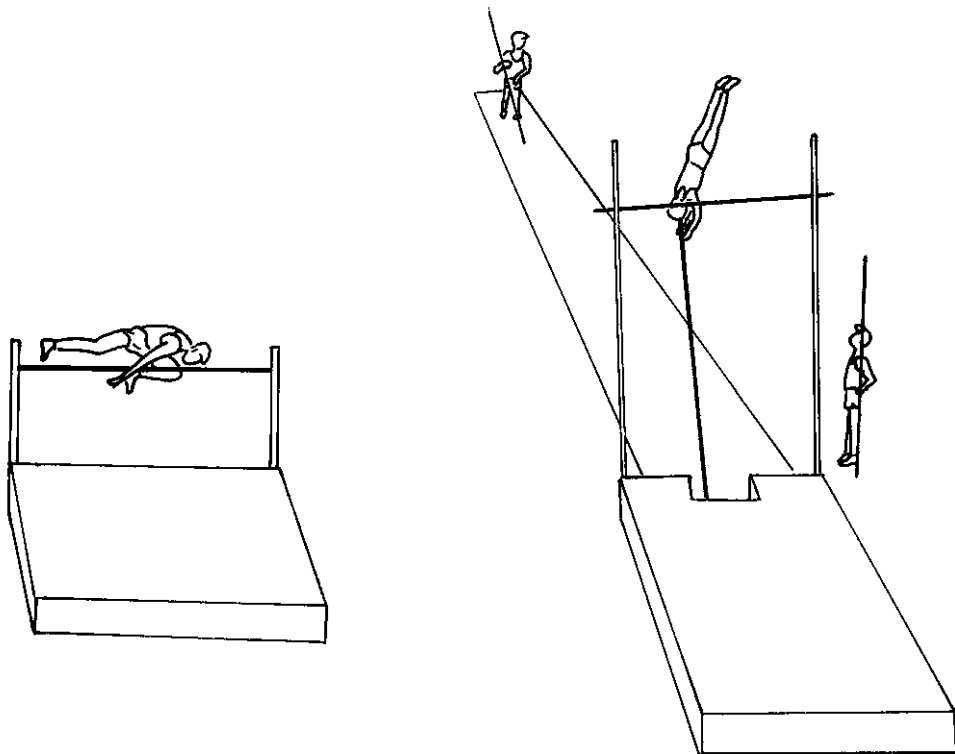

**LESSON  
FOUR**



# LESSON FOUR

## SWIMMING STROKES

### New Words:

**term** :a word or expression ,often used in relation to a particular subject.

(Gliding, floating and strokes are useful swimming terms.)

**technique**: a special way of doing something.

(The swimmer combined different techniques to swim faster.)

**gliding**: moving smoothly and quietly, without much effort.

(The bird was gliding through the air.)

**float**: to stay on top of water.

(Wood floats on water.)

**make progress**: become better.

(Ali has made good progress in his subject this year.)

### Dialogue : At the swimming pool

Akbar : Hello, everybody.

Kamal : Hi, Akbar.

Reza : Hello . How's everything ?

Akbar : Fine. Our swimming instructor taught us some swimming terms and techniques .

Reza : Such as ?

Akbar : Such as gliding ,floating, and strokes.

Reza : I know about gliding and floating, but strokes are new to me.

Akbar : Strokes are the movements of your arms and legs that take you forward in the water.

Kamal : A stroke can also mean the style of swimming.

Akbar : Yes, of course. And there are different types of strokes.  
The most common strokes are the crawl, backstroke, breaststroke, butterfly, and sidestroke .

Reza : It seems you are making good progress in your swimming course .

Akbar : I hope so. I love swimming .

Kamal and

Reza : Good luck. Enjoy your course .

Akbar : Thanks .

## UNDERSTANDING

**PART A :** Write “ T” or “ F” before the following sentences !

- \_\_\_\_\_1. Akbar hopes to improve his swimming skills .  
\_\_\_\_\_2. Reza thinks Kamal is doing well in his swimming course.  
\_\_\_\_\_3. Breaststroke and butterfly are exactly the same.

**PART B :** Complete these short conversations . The words you need are in the dialogue .

1. A: Do you like your swimming course ?  
B: Yes. I think\_\_\_\_\_ .
2. A: Name 3 different types of strokes .  
B: The crawl, the butterfly, and the \_\_\_\_\_.
3. A: Which is the most common type of stroke ?  
B: The \_\_\_\_\_.
4. A: Can you swim the crawl smoothly ?  
B: I \_\_\_\_\_so .
5. A: Are the other students doing well, too ?  
B: Yes. They are making good \_\_\_\_\_ .

### New Words:

**instinct:** a natural tendency that makes people and animals do certain things.

(Most animals swim by instinct.)

**instinctive:** based on instinct.

(Animals have an instinctive fear of fire.)

**afloat:** floating on water.

(He could not swim, and only a life jacket kept him afloat)

**disappear:** to stop existing; to vanish.

(His fear disappeared when he turned on the lights.)

**participate:** to take part in an activity.

(She didn't participate in the contest.)

## SWIMMING

Early man probably learned swimming by observing animals that use a running motion to move about on or in the water. But some scientists believe that human beings are born with an instinctive ability to use their arms and legs to stay afloat. That instinct, however, disappears within a few months after birth. Later in life many children and adults learn to swim in order to be safe around the water, to have fun, and to participate in competitions.

## UNDERSTANDING

**PART A:** Draw a line from a word in column I to a word closest in meaning in column II

I	II
1. observe	a. vanish
2. probably	b. remain
3. motion	c. watch
4. stay	d. contest
5. disappear	e. movement
6. participate	f. almost certainly
7. competition	g. take part



**PART B:** Which of the following statements are false and which are true ? Write “ T” or “ F” before the statement!

- \_\_\_\_\_ 1. According to the passage not all animals can swim .  
\_\_\_\_\_ 2. Human beings can swim within a few months after birth .  
\_\_\_\_\_ 3. Children and adults learn to swim just for competitions.  
\_\_\_\_\_ 4. There are different reasons for children and adults to learn to swim.

**PART C:** Some of the statements are correct and some are incorrect.  
Write correct before the correct statements. Correct the incorrect statements.

- \_\_\_\_\_ 1. Some animals can move in or on the water.  
\_\_\_\_\_  
\_\_\_\_\_ 2. According to the passage, scientists are born with an instinctive ability to swim.  
\_\_\_\_\_  
\_\_\_\_\_ 3. Different people have different reasons to swim .  
\_\_\_\_\_  
\_\_\_\_\_ 4. The instinctive ability to stay afloat appears within a few months after birth .

### **New Words:**

**recreation:** a particular activity that people do for enjoyment when they are not working.

(His recreations are swimming and photography.)

**competition:** a game that people try to win; a contest.

(He entered the table tennis competition and won the cup.)

**efficient:** doing something well and successfully.

(As we get older, our bodies become less efficient in burning up calories.)

**graceful:** moving in a smooth and beautiful way.

(After long hours of practice, Reza became a graceful swimmer.)

## The major strokes

There are different swimming strokes introduced in a swimming course. Four of the five main swimming strokes are used both in competition and recreation. The fifth major stroke, the sidestroke, is slower than the competitive strokes and is used primarily as a recreational and life-saving technique.

The first major stroke is the crawl which is the fastest and most efficient swimming technique. It is also called the freestyle, because swimmers use it in freestyle events, which allow the use of any stroke. Next, there is the backstroke which is the only stroke that is swum on the back. The third major stroke is the breaststroke. Breaststroke is one of the easiest and most relaxing strokes for beginners. Competitive swimmers, however, find it difficult because it uses more energy than the crawl and backstroke when swum at a fast pace. Finally, there is the butterfly stroke which is powerful, graceful, and fast. More than any other stroke, the butterfly relies on good techniques.



crawl stroke

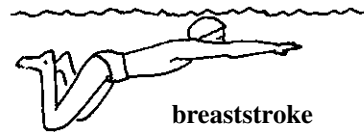

breaststroke



butterflystroke

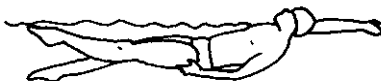

backstroke



sidestroke

different types of stroke.

## UNDERSTANDING

**PART A :** Use the words in the box to complete each of the definition given.

breaststroke      The crawl      crawl  
The sidestroke      backstroke

1. The only stroke that is swum on the back : The \_\_\_\_\_
2. The stroke used mainly as a life-saving technique: \_\_\_\_\_
3. The easiest and most relaxing stroke for beginners: The \_\_\_\_\_
4. Also called the free style : \_\_\_\_\_
5. The fastest and most efficient stroke : The \_\_\_\_\_

**PART B :** Put a check mark (✓) before the correct sentence.

1.
  - a. The sidestroke is faster than the competitive strokes.
  - b. The most difficult and exhausting stroke is the butterfly stroke.
2.
  - a. The backstroke is a life-saving technique.
  - b. When swum at a fast pace , the breaststroke uses a lot of energy.
3.
  - a. Not all of the five major strokes are used as a recreation and life-saving technique .
  - b. All of the five main strokes are used both in recreation and competition.
4.
  - a. Butterfly stroke is not powerful or fast .
  - b. Butterfly stroke is quick and powerful .

# GRAMMAR REVIEW

**PART A:** Follow the examples and fill in the boxes .

<b>EXAMPLE :</b> tall	taller	the tallest
careful	<u>more</u> careful	the <u>most</u> careful
difficult	<u>more</u> difficult	the <u>most</u> difficult
good	better	best

Fast	_____	_____
Slow	_____	_____
Free	_____	_____
Easy	_____	_____

Many	_____	_____
Much	_____	_____
Little	_____	_____
Bad	_____	_____

Graceful	_____	_____
Powerful	_____	_____
Relaxing	_____	_____
Competitive	_____	_____
Efficient	_____	_____
Exhausting	_____	_____
Interesting	_____	_____

**Fill in the gaps with the correct form of the adjective.**

1. The breaststroke is one of the \_\_\_\_\_( easy) and \_\_\_\_\_(relaxing ) strokes for beginners .

2. The crawl is the \_\_\_\_\_(fast ) and \_\_\_\_\_(efficient) swimming technique.

3. The sidestroke is \_\_\_\_\_(slow) than the competitive strokes.

4. The \_\_\_\_\_(difficult) and exhausting stroke is the butterfly.

5. Swimming strokes should create the \_\_\_\_\_(little) possible resistance.

### FURTHER ACTIVITIES:

**I-TRANSLATION:** Translate the following sentence into Persian . Use your dictionary for new words.

The average person on the pool deck will not be impressed with the strength of your scissors kick or the length of your breaststroke glide, but will notice immediately how smoothly and easily you swim the crawl.

**II- TEST YOURSELF:** Write the following words under the corresponding pictures!

breaststroke   butterfly stroke   crawl stroke   sidestroke



1. \_\_\_\_\_



2. \_\_\_\_\_

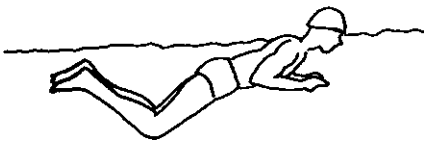

3. \_\_\_\_\_

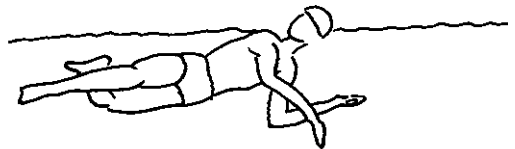

4. \_\_\_\_\_

# LESSON FIVE

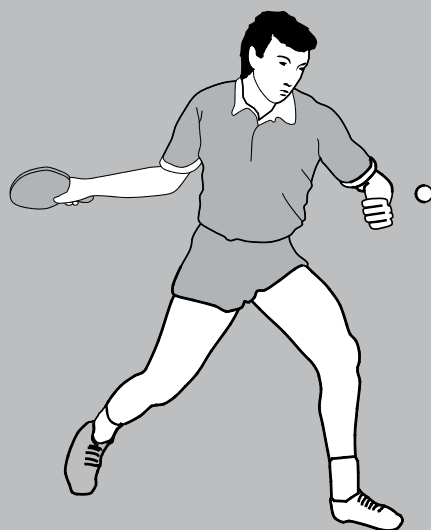

# LESSON FIVE

## TABLE TENNIS

### New Words:

**review** : go over.

**regular** : evenly or systematically arranged.

**regularly**: state of being regular.

**tight** : fixed ,fastened , or drawn together firmly.

### Dialogue :Let's review some points.

Mina : Hello.

Zahra: Hi. How are you today?

Mina : Fine ,Thanks. I am going to have a test on table tennis today.

Zahra: Why don't you review some skills and techniques before the exam?

Mina : I've already practiced different types of grips.

Zahra: Do you mean shake hand and penholder grips ?

Mina : That's right. By the way, did you know that shake hand grip is also called the western grip?

Zahra: No, I didn't. Anyway , remember: Do not grip the racket too tightly .

Mina : I'll try to remember that.

Zahra: One more thing. Regularly check the thumb and index finger to keep them in the proper place .

Mina : Thank you very much .

Zahra: You're welcome .Good luck .

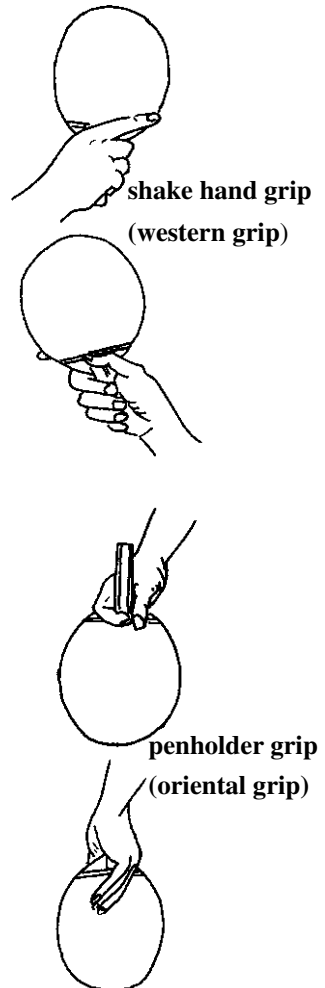

## UNDERSTANDING

**PART A:** Which of the following sentences are true and which are false. Write “T” or “F” before the sentences.

- \_\_\_\_\_ 1. The thumb and index finger are very important in gripping the racket.
- \_\_\_\_\_ 2. The shake hand grip is the same as western grip.
- \_\_\_\_\_ 3. You must grip the racket very tightly.

**PART B:** Fill in the gaps. Use the words and expressions appeared in the dialogue.

1. There are two main types of grip in table tennis, \_\_\_\_\_ and \_\_\_\_\_.
2. You have to check your \_\_\_\_\_ and \_\_\_\_\_ finger regularly when playing table tennis.
3. In table tennis you need some \_\_\_\_\_ and skills.

### New Words:

**back and forth:** from one place to another and back again repeatedly.

**miss :** to fail to hit, catch, or reach.

**successive:** coming one after the other in an unbroken rally.

**popular:** liked by many people.

(Football is a very popular game in Iran.)

**popularity:** Being liked by a lot of people.

( The reason for popularity of football is that it is a very exciting sport.)

**indoor:** done or used inside a building.

(An indoor swimming pool is much more expensive.)

**outstretched:** stretched or spread as far as possible.

(He balanced himself with outstretched arms.)

**strike :** Hit.

(The football player struck the ball beautifully.)



## TABLE TENNIS

Table tennis, also called Ping-Pong, is an excellent home game for the entire family. One of the reasons for its popularity is that persons of any age and either sex can play the game all the year round. It is usually played indoors , by two or four players .



**a feather**

Table tennis causes little or no damage or injury indoors because a small racket and a ‘light as a feather’ ball are used. The ball is 40mm in diameter and 2.7g in weight .

Table tennis involves hitting the ball back and forth over the net until one of the players misses the ball, or hits it into the net or off the table. In each of these cases the opponent scores a point. To serve properly , a player holds the ball on the flat ,outstretched palm of the hand then throws it up and strikes it as it falls. The ball must then hit the table on server’s side of the net first and then play continues as in tennis, but the ball must hit the table before being returned by a player.

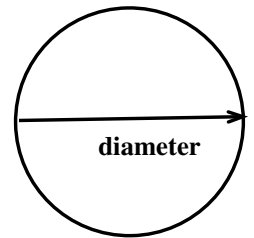

One player serves until 2 points have been scored, after which the opponent serves for the next 2 points. A game is won by the player who first scores 11 points, unless both players have scored 10 points, in which case the one who first scores 2 successive points more than the opponent is the winner.



**a flat palm**

## UNDERSTANDING

**PART A:** Which of the following sentences are true and which are false . Write “ T” or “ F” before the sentences.

- \_\_\_ 1. Table tennis is different from Ping-Pong.
- \_\_\_ 2. Both sexes can play the game.
- \_\_\_ 3. During the game, if you score two points more, you are the winner.
- \_\_\_ 4. The racket is 40 mm in diameter.
- \_\_\_ 5. “ It” in line 5 refers to table tennis.

**PART B:** Give oral answers to the following questions !

- 1. Why is table tennis so popular ?
- 2. What does “entire” mean in line 2 ?
- 3. How old are the people who play table tennis ?
- 4. Who is the winner?

**PART C:** Read the following statements carefully. Some of these sentences are correct, and some are incorrect. Write **correct** next to the correct sentences. Correct the incorrect sentences.

- \_\_\_ 1. Table tennis involves hitting the table back and forth.
- \_\_\_ 2. The opponent scores a point if the other players misses the ball.
- \_\_\_ 3. Table tennis causes a little or some damage indoors.
- \_\_\_ 4. You win the game if you first score 21 points.
- \_\_\_ 5. To serve properly, a player holds the ball on the flat open palm ,then throws it up and strikes it as it falls.

**PART D:** Use the words in the box to complete the sentences that follow.

lightweight    net    forth    excellent    diameter

- 1. The ball is 40 mm in \_\_\_\_\_.
- 2. Tennis is a(n)\_\_\_\_\_ home game for all the members of the family.

3. To play table tennis you need a small racket and a \_\_\_\_\_ ball.
4. If a player hits the ball into the \_\_\_\_\_, the opponent scores a point.
5. Table tennis involves hitting the ball back and \_\_\_\_\_ over the net.

**PART E:** Use the words in column B closest in meaning with the words in column A . Write a,b,c,...etc. in the spaces.

_____ A _____	_____ B _____
1. properly     ()	a. strike
2. hold         ()	b. correctly
3. hit           ()	c. keep
4. go back     ()	d. if not
5. whole       ()	e. return
6. unless      ()	f. entire

**PART F:** Match the word in the box with the definition given!

miss      properly      grip      return  
 popular    opponent      successive

1. liked by many people : \_\_\_\_\_
2. correctly : \_\_\_\_\_
3. person who is against another person in a fight or game : \_\_\_\_\_
4. take and keep a firm hold of something or someone : \_\_\_\_\_
5. coming one after the other in an unbroken series : \_\_\_\_\_
6. send back : \_\_\_\_\_
7. to fail to hit ,catch or reach : \_\_\_\_\_