

* به پدر و مادر خود نیکی کنید.
قرآن کریم

بخش ۱

نگاره‌ها

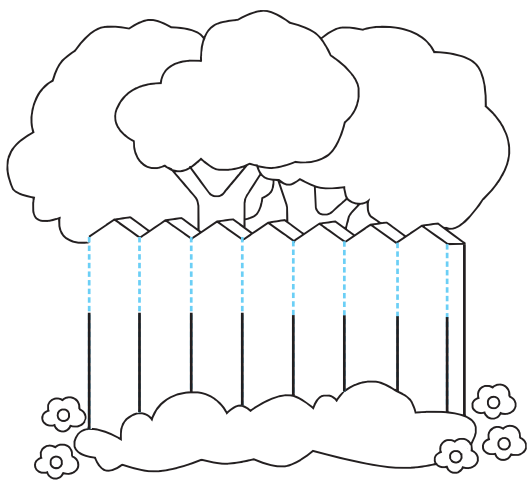

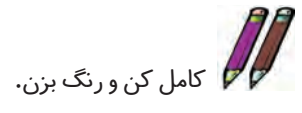
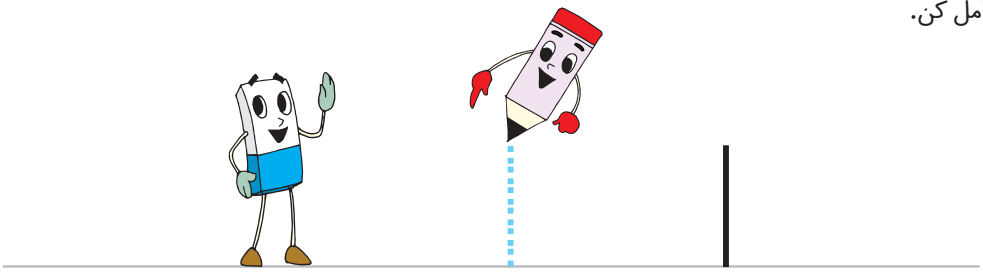



Handwriting practice lines consisting of a top row with vertical tick marks and a downward arrow, followed by three horizontal blue lines.



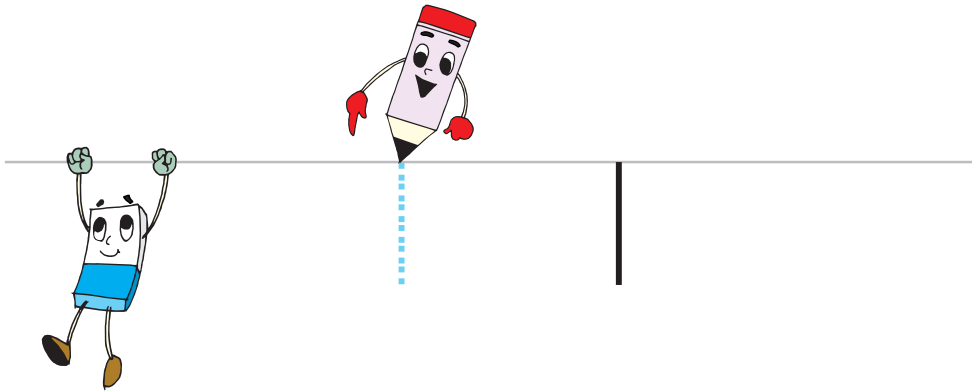

کامل کن. 



کامل کن و رنگ بزن. 

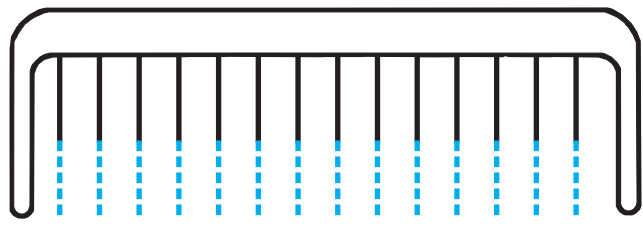

بنویس. 



کامل کن.



سلام!

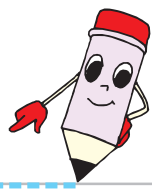
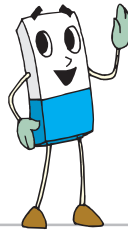

کامل کن و رنگ بزن.

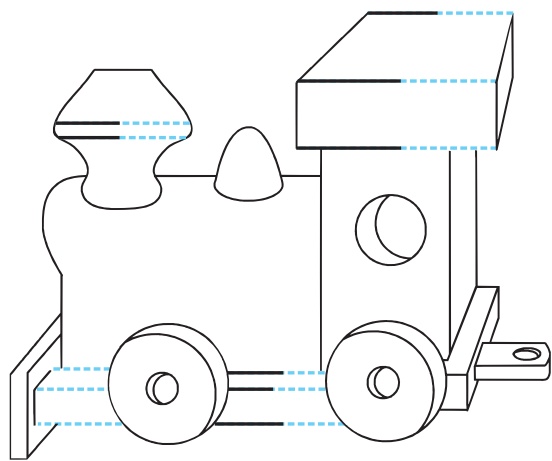



بنویس.



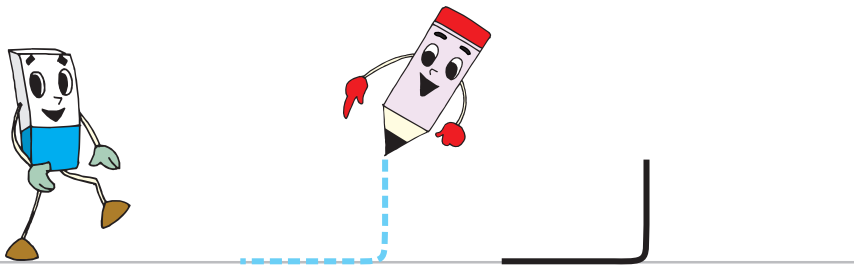

کامل کن. 



کامل کن و رنگ بزن. 

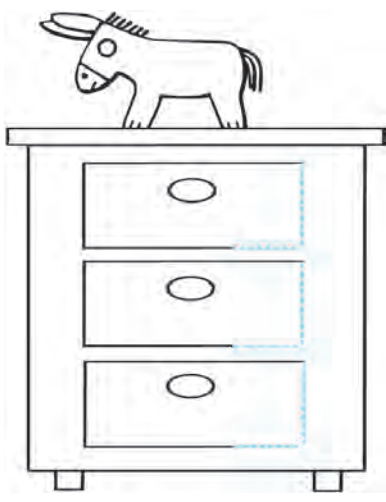

بنویس. 

Handwriting practice lines with a 'J' character for tracing and a vertical column of four empty boxes on the left.



سلام
دوست من!

کامل کن.

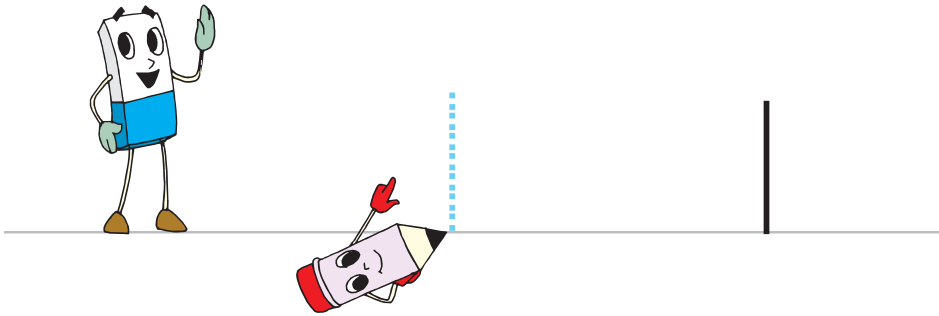

کامل کن و رنگ بزن.

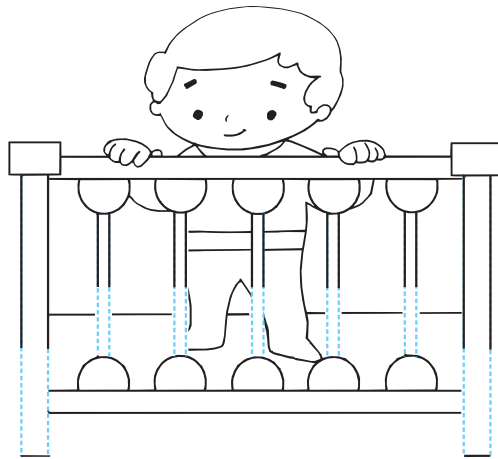

بنویس.



Handwriting practice lines consisting of a top line, a middle line, and a bottom line. The top line has vertical tick marks. A red arrow points upwards from the bottom line on the right side.





کامل کن.

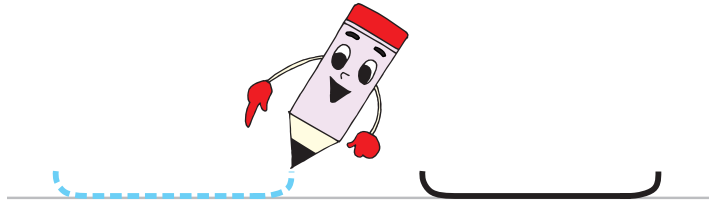

کامل کن و رنگ بزن.

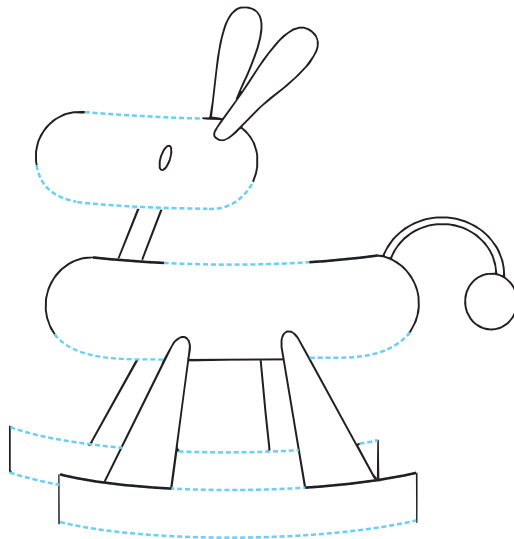

بنویس.



سلام،
روز به خیر!

کامل کن.

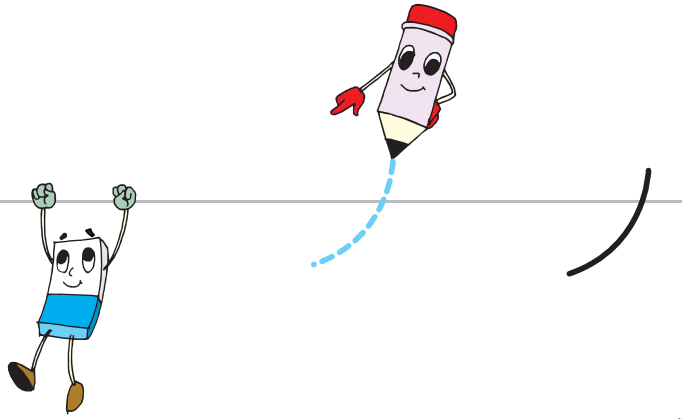

کامل کن و رنگ بزن.

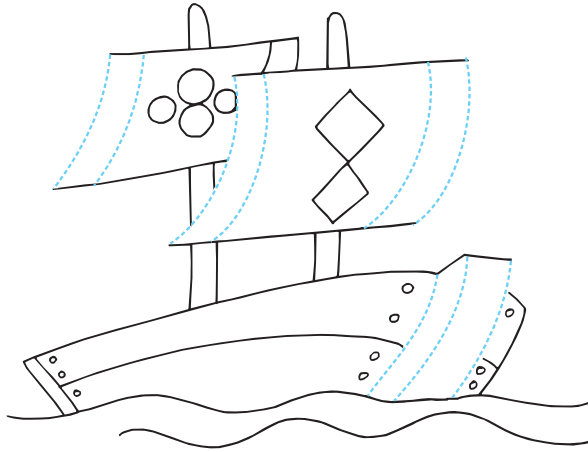

بنویس.



خسته نباشی!



کامل کن. 

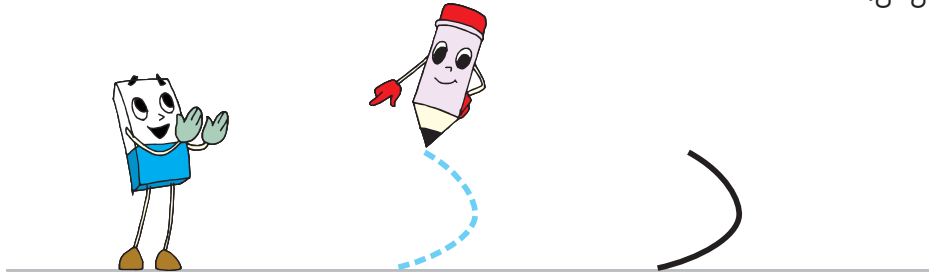

کامل کن و رنگ بزن. 

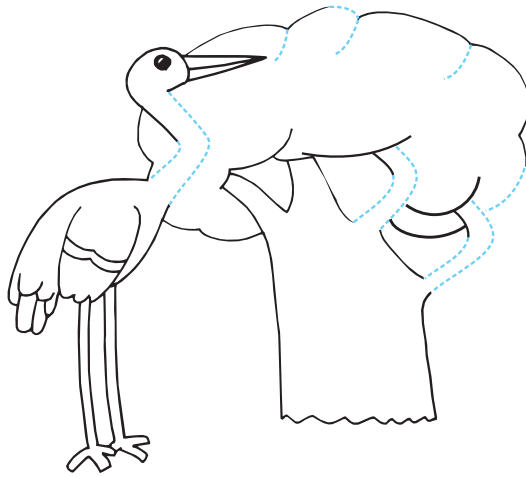

بنویس. 

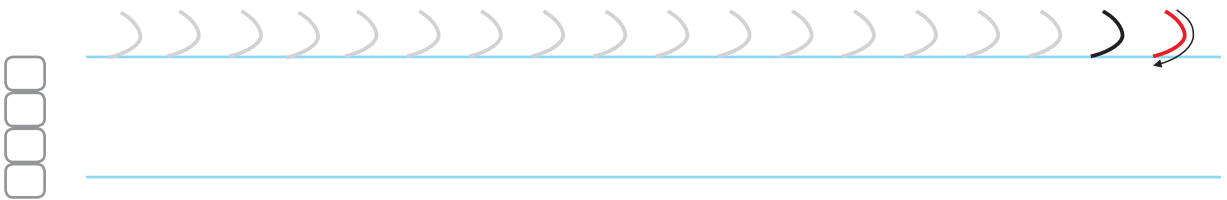

سلام،
روز به خیر!

کامل کن.

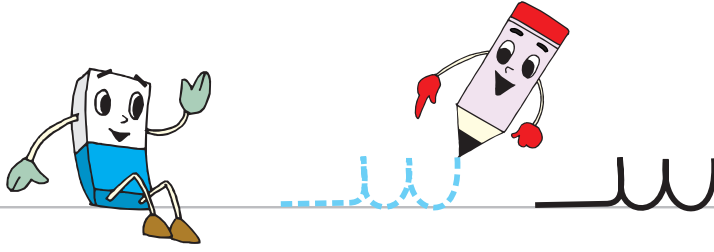

کامل کن و رنگ بزن.

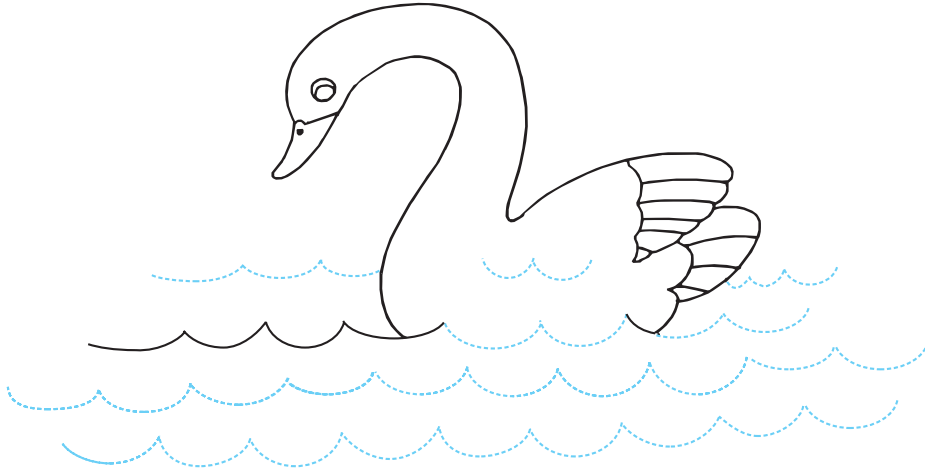

بنویس.





کامل کن.

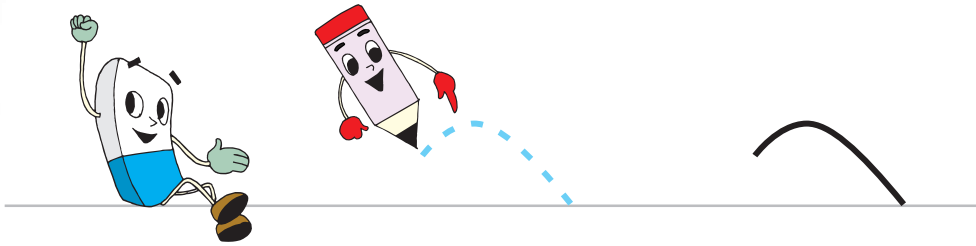

کامل کن و رنگ بزن.

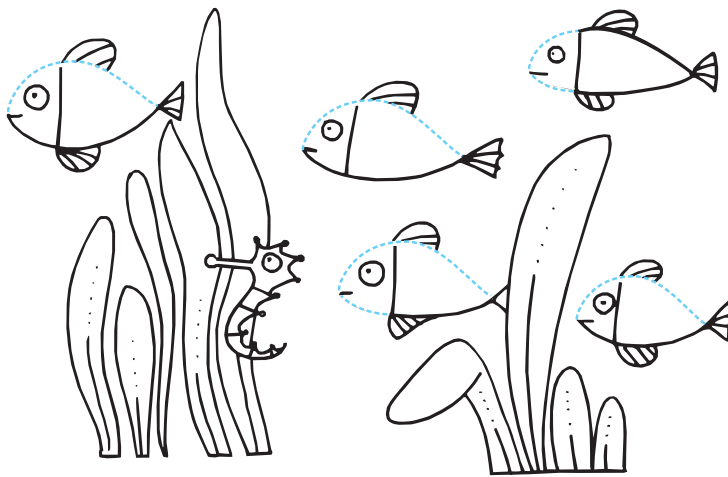

بنویس.

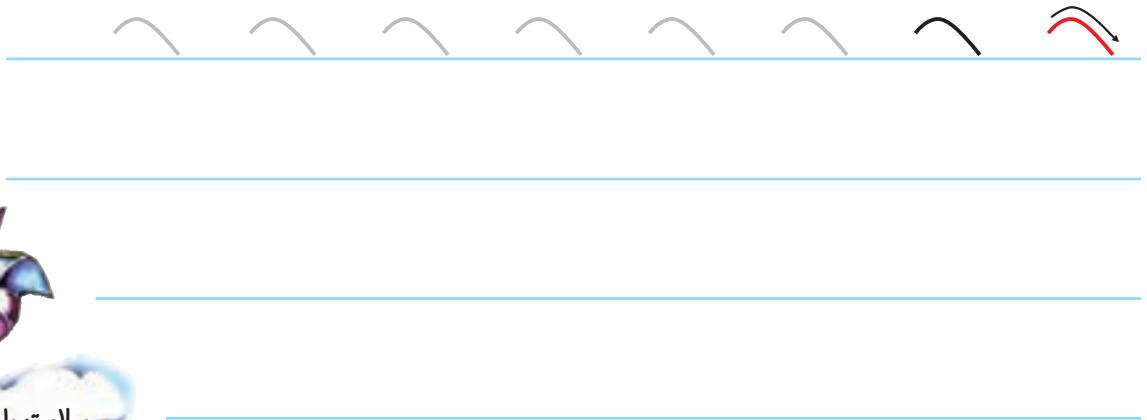

سلام،
روز به خیر!

کامل کن.

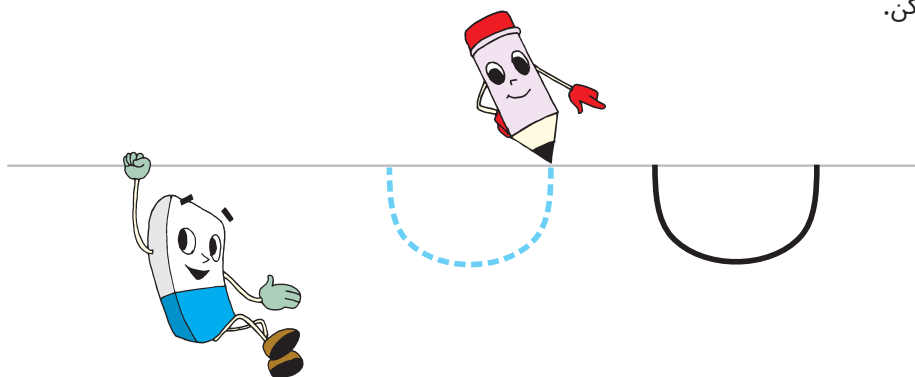

کامل کن و رنگ بزن.

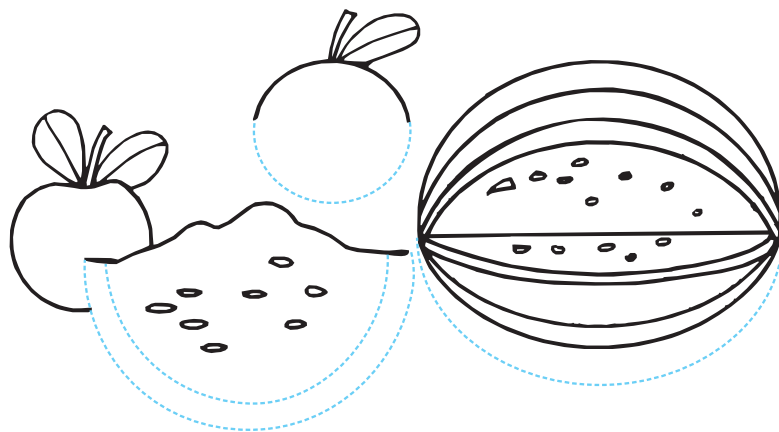

بنویس.

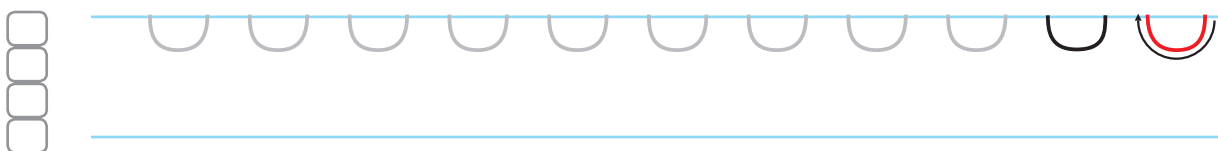

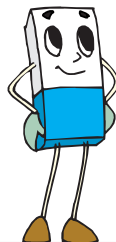

کامل کن. 

کامل کن و رنگ بزن. 

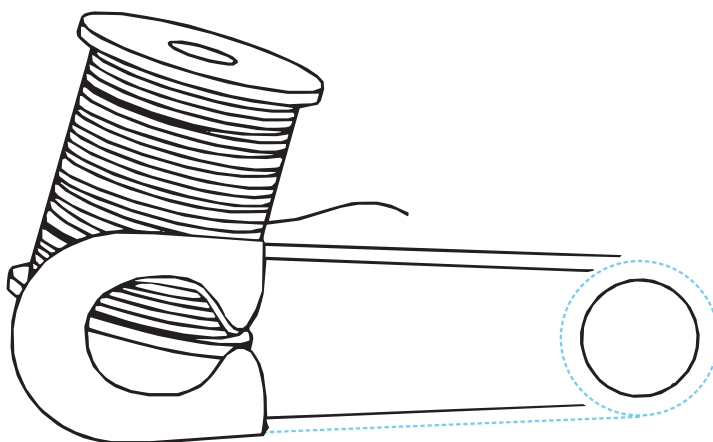

بنویس. 



روزت به خیر!

سلام
هم شاگردی!

کامل کن.

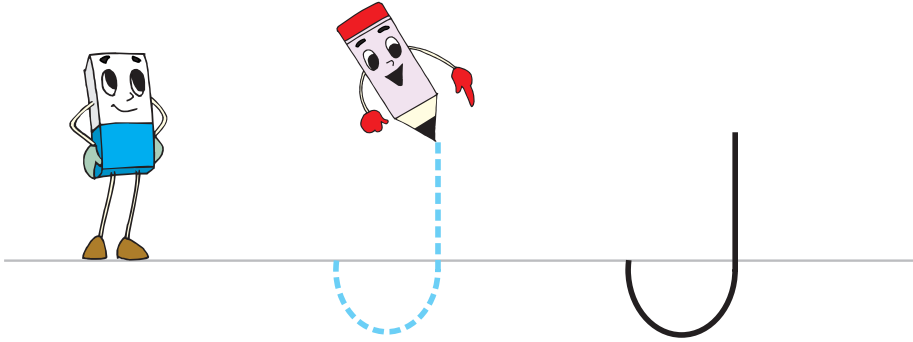

کامل کن و رنگ بزن.

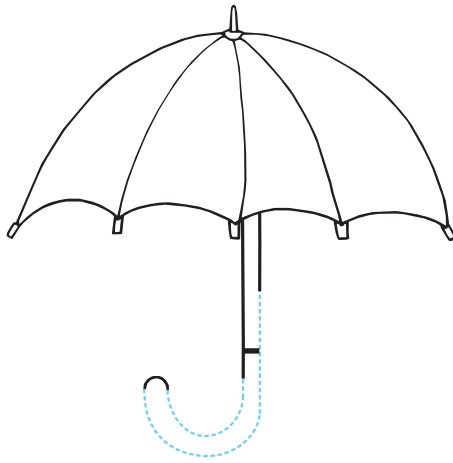



بنویس.



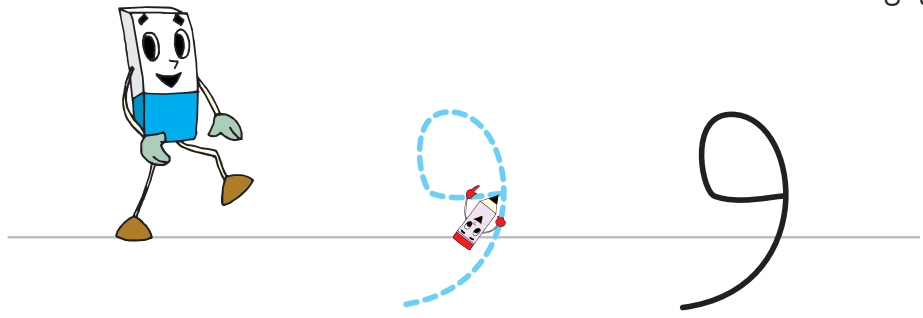

کامل کن. 



کامل کن و رنگ بزن. 

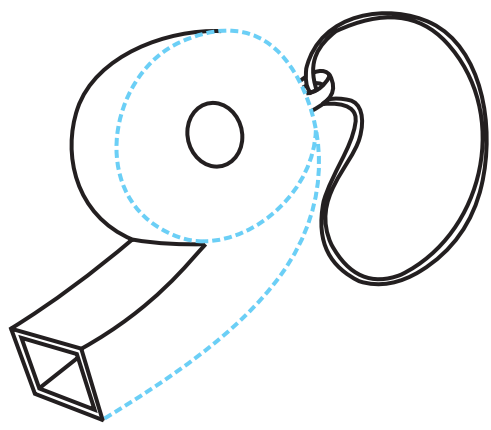

بنویس. 

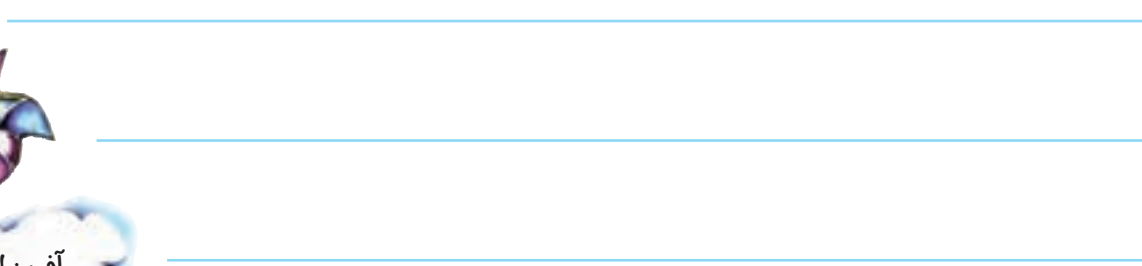

دوست من
سلام!

کامل کن.

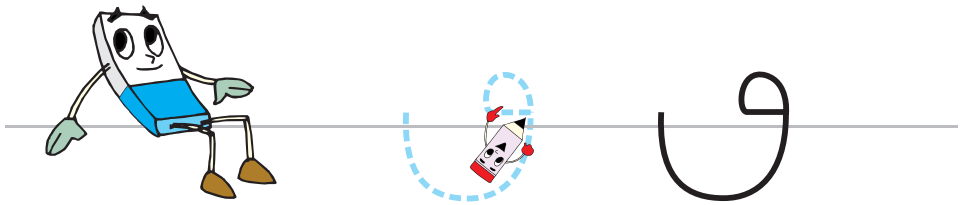

کامل کن و رنگ بزن.

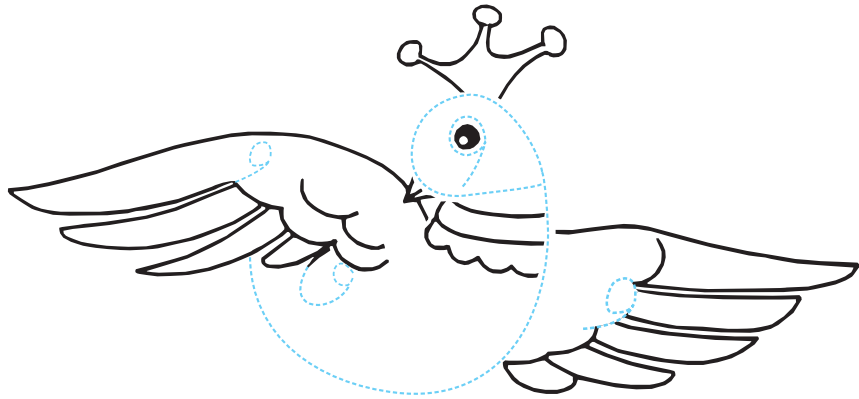

بنویس.

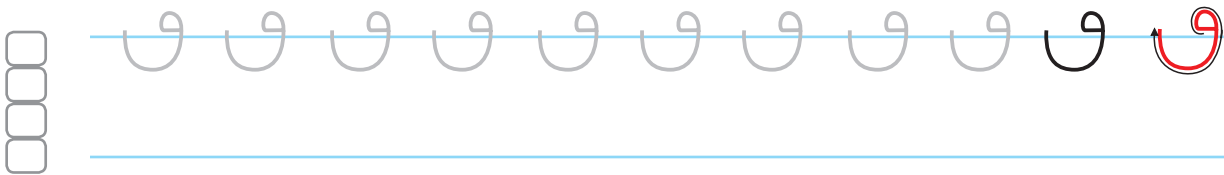

با هم مهربان
باشیم!



کامل کن. 



کامل کن و رنگ بزن. 

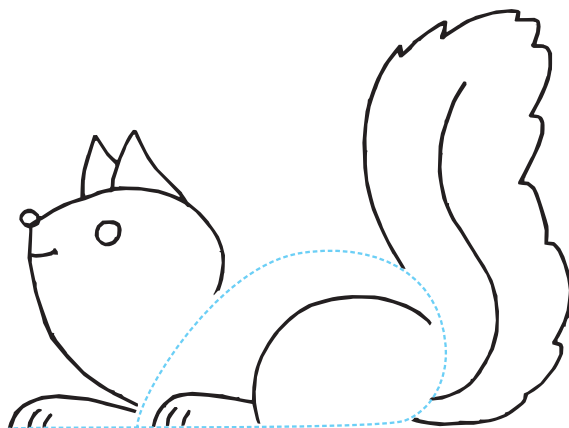

بنویس. 



کامل کن.

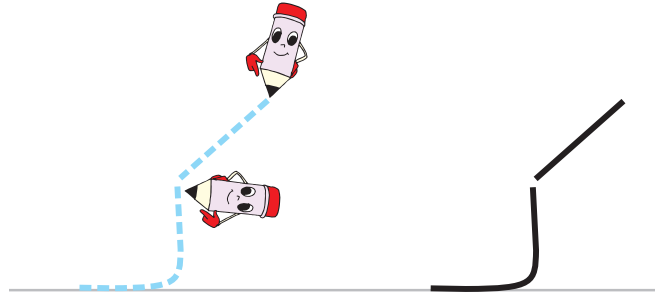

کامل کن و رنگ بزن.

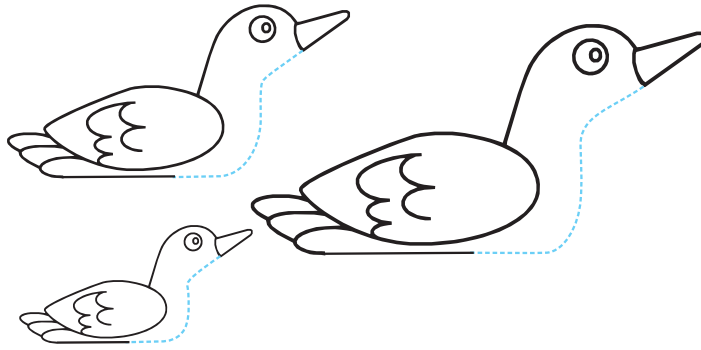



بنویس.



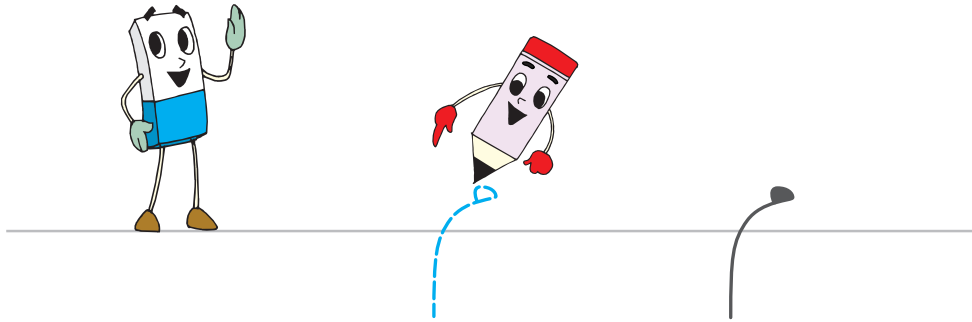

کامل کن. 



کامل کن و رنگ بزن. 

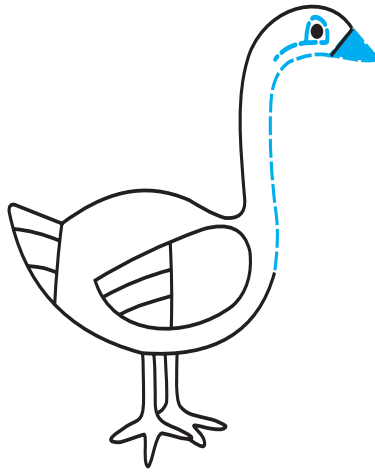

بنویس. 

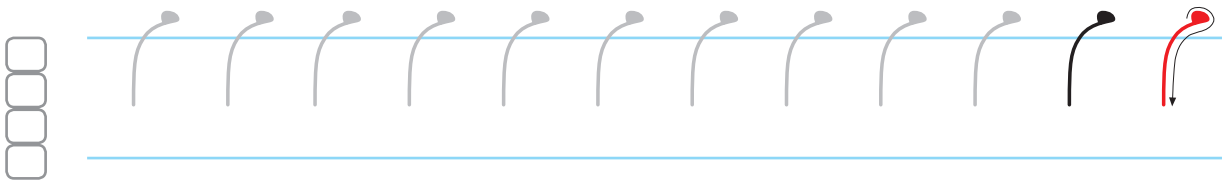

هم کلاسی
سلام!

کامل کن.

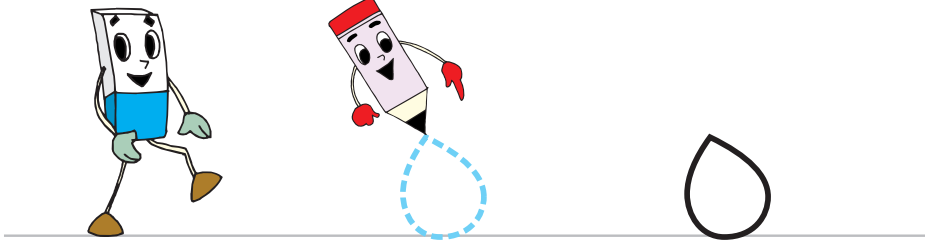

کامل کن و رنگ بزن.

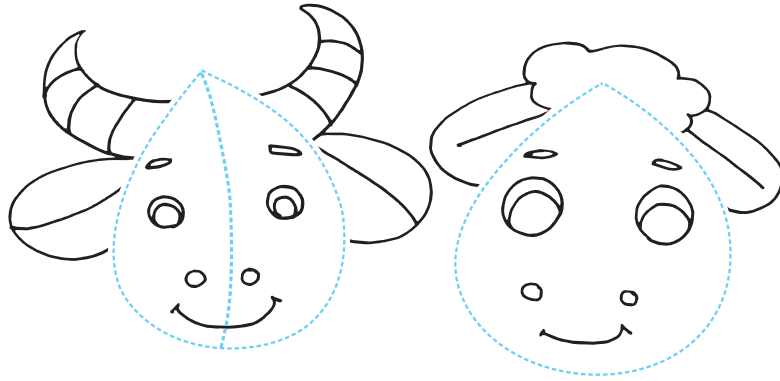



بنویس.



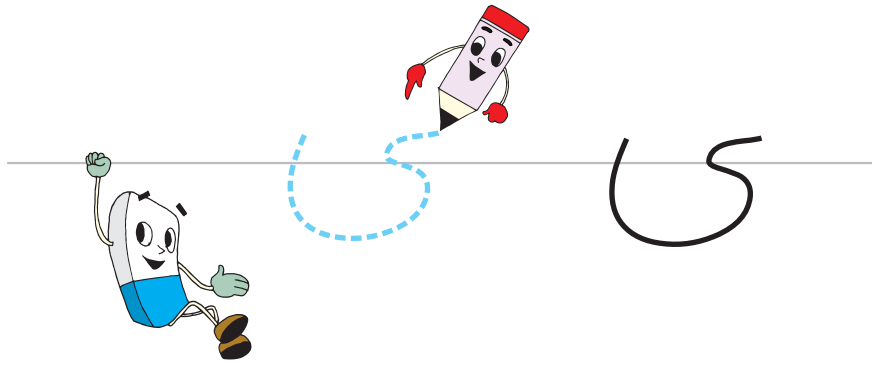

کامل کن. 



کامل کن و رنگ بزن. 

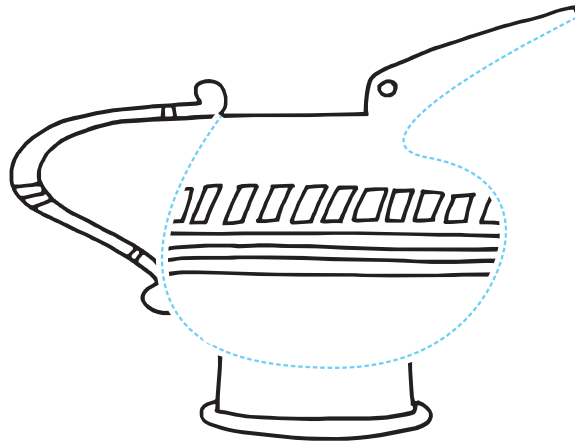

بنویس. 



ی ی ی ی ی ی ی ی ی ی ی



شادباش!



بنویس.

س س س س س س س س س س

Blank handwriting lines for practicing the letter 'س'.

ح ح ح ح ح ح ح ح ح ح

Blank handwriting lines for practicing the letter 'ح'.

ح ح ح ح ح ح ح ح ح ح

Blank handwriting lines for practicing the letter 'ح'.





ب ب ب ب ب ب ب ب

Blank handwriting lines for practicing the letter 'ب'.

ه ه ه ه ه ه ه ه

Blank handwriting lines for practicing the letter 'ه'.

د د د د د د د د

Blank handwriting lines for practicing the letter 'د'.

